

Contents

Operating the Printer Safely	1
Part Names and Descriptions.....	3
Front of the Printer	3
Rear of the Printer	4
Front Cover	5
Operation Panel.....	6
Basic Card Printing Methods	8
Turning On and Off the Printer.....	8
Loading Cards	9
Loading Cards into the Card Case	9
Manually Loading Cards One by One	10
Printing.....	11
Removing Cards	12
Changing the Ink Ribbon Cartridge	13
When a Change is Necessary	13
Changing the Cartridge.....	13
Normal Mode and User Mode	15
Normal Mode and User Mode.....	15
Normal Mode	15
User Mode	15
Switching to User Mode.....	16
Basic User Mode Operations.....	17
Moving to the Next Menu (Switching to Menus on the Same Level)	17
Moving to a Sub-menu (Switching to Menus on a Lower Level).....	17
Returning to the Main Menu (Switching to Menus on a Higher Level)	18
Switching to Normal Mode (Exiting User Mode).....	18
Getting the Most Out of Your Printer	19
Reprinting a Card that Has Just Been Printed.....	19
Counting the Number of Cards that Are Printed	20
Displaying the Total Number of Sides that Are Printed	20
Switching the Card Ejection Slot.....	21
Checking the Ink Ribbon Remaining in the Ink Ribbon Cartridge.....	22
Checking the Ink Ribbon Cartridge that is Currently Installed	23
Adjusting the Print Quality	24
Adjusting the Color	24
Adjusting the Edges of Images.....	26
Turning the Error Alarm On or Off.....	27

Full Color Card Printer **PR-C101/C101M**

Setting the Printer to Reprint a Card if an Error Occurs	28
Checking the Program Information and Serial Number	29
Changing the Magnetic Encoder's Settings (PR-C101M Only)	30
Returning Settings to the Default.....	30
Preventing Theft and Unauthorized Usage.....	31
Preventing Theft of the Printer (Security Cable Slot).....	31
How to Store Cards (Removing the Card Case).....	31
Cleaning	32
Before Cleaning	32
Cleaning with a Cleaning Card	32
Cleaning the Cleaning Roller	34
Cleaning the Feeding Roller	35
Troubleshooting.....	36
When an Error Message Appears... ..	36
Clearing an Error.....	36
How to Clear an Error.....	36
When a Card is Jammed... ..	39
When Cards are Not Printed Correctly.....	40
Other Troubles	41
When These Solutions Don't Work.....	41
Appendix	42
Consumables.....	42
Ink Ribbon Cartridges.....	42
Cards	43
Cleaning Cards.....	43
Updating the Printer's Software	43
Menu Route Map (User Mode)	44
Main Specifications.....	46
Opening the Printer Driver Settings Screen.....	47
Opening the Setting Screen (From the Start Menu).....	47
Opening the Setting Screen (From the Application).....	47
Changing the Settings or Confirming the Status from the Setting Screen... ..	47

Operating the Printer Safely

The following precautions must be observed to assure safe operation of the printer. Also, do not do anything that is not described in this manual. Doing so may cause an unexpected accident.

⚠ WARNING Failure to observe the following items while using the printer may cause a fire, electric shock or other unexpected accident.

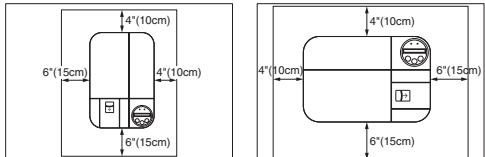
Installation location	Do not install the printer in a damp or dusty location
	Do not install the printer flammable or explosive materials or near a heater, stove or other device that produces heat.
	Place the printer away from any walls, as shown in the diagram below, to maintain air flow. Also, maintain at least 4" (10 cm) of open space above the printer. Blocking the the vents may cause the printer to overheat and catch on fire.
	 <p>The left diagram shows the value of minimum air flow space from any walls when the Card Stacker is not attached. If you attach the Card Stacker, the * value increases to 6" (15 cm).</p>
Power supply	Use a dedicated power cable and do not use an extension cord with multiple outlets.
	Be sure to remove any dust from the plug and outlet. Humidity produces a micro-current on the surface causing overheating or a fire.
	Do not damage or modify the Power Cable. Also, do not place heavy objects on it, pull it, or bend it excessively.
	Do not plug in or unplug the Power Cable if your hands are wet.
	Be sure to turn off the power and unplug the plug from the outlet before moving the printer.
	Pull on the plug, not the cable, when unplugging it from an outlet.
Handling	Do not use flammable sprays near the printer.
	Do not touch anything inside the printer unless specified in this manual.

Full Color Card Printer **PR-C101/C101M**

⚠ CAUTION Failure to observe the following items while using the printer may cause injury or a malfunction.

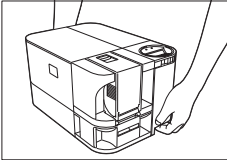
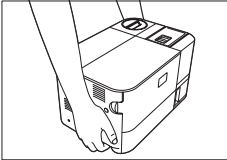
Installation location	Do not install the printer on a wobbly table, on a slant, or anyplace where there is excessive vibration.
	Do not install the printer in a location susceptible to rapid fluctuations in temperature.
	Do not install the printer in a location exposed to direct sunlight.
Power supply	Do not use an under-rated extension cord (The rated voltage varies according to the area of purchase).
Handling	Do not place heavy items on the printer and do not lean on the printer.
	If you move the printer, carry it as shown below.
	<div style="display: flex; justify-content: space-around;">   </div>
While the printer is operating, do not turn off the power, unplug the power cable, or look inside the printer.	

- The cooling fan is always running to cool the inside of the printer. This is not a malfunction.
- Contact your reseller if there is a current leak.
- The printer may cause static, flickering or interrupt reception of televisions or radios if they are too close to the printer.

⚠ CAUTION Regarding copyrights
Using portraits (photos or images) or copyrighted material (illustrations or logos) without the permission of their owners is prohibited by law.
Do not use copyrighted images without permission or for illegal activities.

⚠ CAUTION Under the following conditions images on cards may deteriorate or cards may warp after printing.

- The surface of the card is in contact for an extended period of time with a vinyl card folder or synthetic leather or other material that contains plasticizer.
- The surface of the card is exposed to direct sunlight for an extended period of time.
- The card is repeatedly rubbed against a hard object.
- The faces of two cards are in contact for an extended period of time.
- The card is kept for an extended period of time in a very hot location such as a car parked in the sun.

If a card with a magnetic strip is placed near a magnetic source, the data on the strip may be corrupted.

Part Names and Descriptions

Front of the Printer

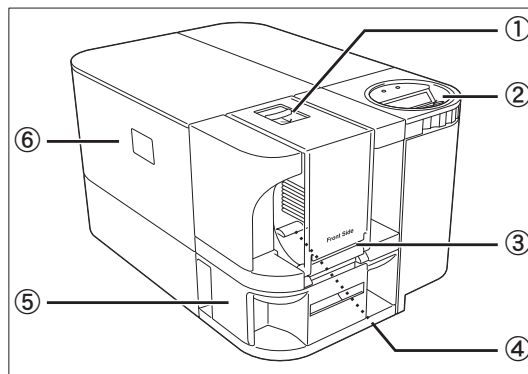

① Card Case

Up to 100^{*1} cards can be loaded at one time.

→See "Loading Cards" on page 9 for instructions on loading the Card Case.

→See "Cards" on page 43 for details about which cards you can use.

② Operation Panel

Includes the keys, the LCD Panel, and indicator for operating the printer.

→See "Operation Panel" on page 6 for part names and descriptions.

→See "Normal Mode and User Mode" on page 15 for information about basic operations.

③ Card Feeding Slot

You can load cards manually, one by one.

→See "Manually Loading Cards One by One" on page 10 for instructions on loading manually.

→See "Cards" on page 43 for details about which cards you can use.

④ Feeding Roller

Pulls loaded cards into the printer.

→See "Cleaning the Feeding Roller" on page 35 for cleaning instructions.

⑤ Card Ejection Slot 1

Ejects correctly printed cards and cards with errors.

It has a maximum capacity of 30^{*1} cards. You can select between Card Ejection Slot 1 and 2 for card ejection.

→See "Switching the Card Ejection Slot" on page 21 for information about switching the card ejection slot.

⑥ Front Cover

Open this cover to change the Ink Ribbon Cartridge and clean the roller.

→See "Front Cover" on page 5 for information about the names of parts inside the cover and their descriptions.

→See "Changing the Ink Ribbon Cartridge" on page 13 for details about changing the Ink Ribbon Cartridge.

→See "Cleaning" on page 32 for cleaning instructions.

^{*1} When using CR-80 cards (size: 3.375" x 2.125" (86 mm x 54 mm), thickness: 0.03" (0.76 mm)).

Full Color Card Printer PR-C101/C101M

Rear of the Printer

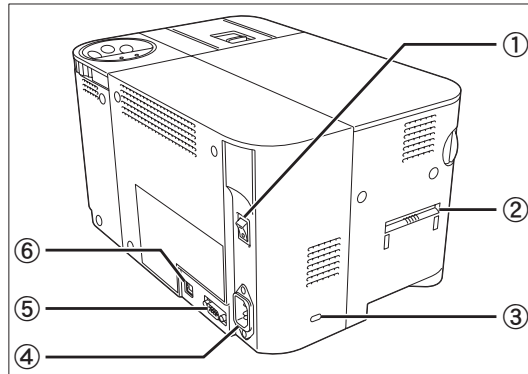

- | | |
|---|---|
| <p>① Power Switch
Turns the power on and off.
→See "Turning On and Off the Printer" on page 8 for instructions on turning the power on and off.</p> <p>② Card Ejection Slot 2
Ejects correctly printed cards and cards with errors.
A maximum of 50^{*1} cards can be stacked by attaching the provided Card Stacker.
You can select between Card Ejection Slot 1 and 2 for card ejection.
→See "Switching the Card Ejection Slot" on page 21 for information about switching the card ejection slot.</p> <p>③ Security Cable Slot
Use the Security Cable Slot to prevent theft of the printer.
→See "Preventing Theft of the Printer (Security Cable Slot)" on page 31 for instructions on using the Security Cable Slot.</p> | <p>④ Power Cable Port
Used to connect the provided Power Cable.
→See the "Easy Setup Guide" for instructions on connecting the cable.</p> <p>⑤ Port for Enhancing Function
Used for enhancing a function.</p> <p>⑥ USB Port
Used for connecting to a computer with the provided USB cable.
→See the "Easy Setup Guide" for instructions on connecting the cable.</p> |
|---|---|

*1 When using CR-80 cards (size: 3.375" x 2.125" (86 mm x 54 mm), thickness: 0.03" (0.76 mm)).

Front Cover

Interior of the Front Cover

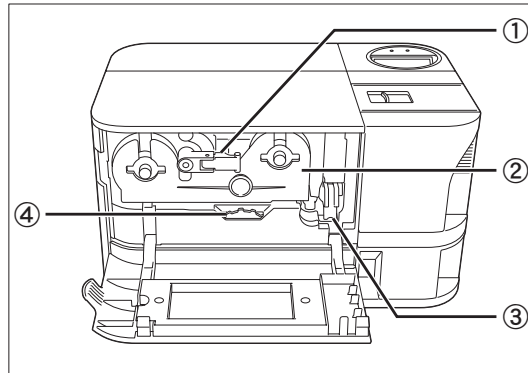

① **Ink Ribbon Cartridge Securing Lever**

Used when loading the Ink Ribbon Cartridge into the printer.

→See "Changing the Ink Ribbon Cartridge" on page 13 for details about changing the Ink Ribbon Cartridge.

② **Ink Ribbon Cartridge**

This cartridge contains the ink ribbon.

→See "Changing the Ink Ribbon Cartridge" on page 13 for details about changing the Ink Ribbon Cartridge.

→See "Ink Ribbon Cartridges" on page 42 for details about which Ink Ribbon Cartridges you can use.

③ **Cleaning Roller**

Removes dirt and other foreign matter stuck to the cards.

→See "Cleaning the Cleaning Roller" on page 34 for cleaning instructions.

④ **Ejection Dial**

Rotating the dial to the left ejects cards jammed in the printer from Card Ejection Slot 2.

→See "When a Card is Jammed..." on page 39 for instructions on how to eject jammed cards.

Full Color Card Printer PR-C101/C101M

Operation Panel

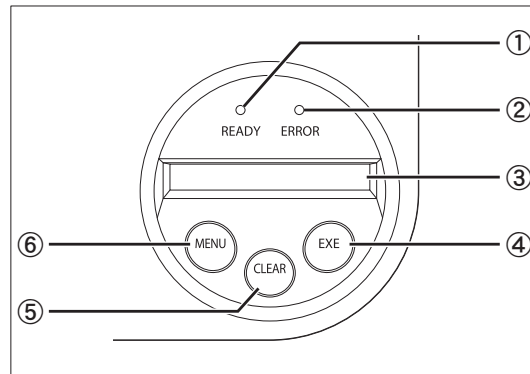

- ① **READY Indicator (Blue Indicator)**
This indicator is constantly lit, blinks (fast or slow) or is not lit depending on the status of the printer.
- ② **ERROR Indicator (Red Indicator)**
Lights when an error occurs.
→See "Troubleshooting" on page 36 when an error occurs.
- ③ **LCD Panel**
Displays the printer's status.
Also displays messages related to the printer's status in Normal Mode, settable menus in User Mode, and displays the information about errors that occur.
→See "Normal Mode and User Mode" on page 15 for details about Normal Mode and User Mode.
→See "Troubleshooting" on page 36 when an error occurs.
- ④ **EXE Key**
Used to reprint the last card printed when the READY Indicator is lit.
In User Mode, it opens the display menu and increases setting values.
→See "Reprinting a Card that Has Just Been Printed" on page 19 for details on reprinting a card.
→See "Basic User Mode Operations" on page 17 for details on changing the User Mode settings.
- ⑤ **CLEAR Key**
Used to clear errors.
In User Mode, it decreases the setting values.
→See "Troubleshooting" on page 36 when an error occurs.
→See "Basic User Mode Operations" on page 17 for details on changing the User Mode settings.
- ⑥ **Menu Key**
Switches between Normal Mode and User Mode. In User Mode, it is used to switch between menus.
→See "Normal Mode and User Mode" on page 15 for details about Normal Mode and User Mode.

Part Names and Descriptions

Note

- You can check the status of the printer by looking at the READY Indicator or ERROR Indicator.
 - READY Indicator is lit ... Ready for printing.
 - READY Indicator is blinking (fast) ... Receiving print data from the computer.
 - READY Indicator is blinking (slow) ... Printer is in use.
 - READY Indicator is not lit ... An error has occurred.
 - ERROR Indicator is lit ... An error has occurred.
 - ERROR Indicator is blinking ... The amount of ink ribbon remaining comes near to an end.

Full Color Card Printer PR-C101/C101M

Basic Card Printing Methods

This section explains the basic flow of operations, from turning on the power through printing a card.

Turning On and Off the Printer

Turn on the printer before starting to print.

Before turning on the power, make sure the following preparations are complete:

- The Ink Ribbon Cartridge is loaded
- The Card Case is loaded
- The cards are loaded
- The Front Cover is closed
- The printer is connected to the computer
- The printer driver is installed



REF

- If the preparations above have not been performed, follow the instructions in the "Easy Setup Guide".

1

Press the Power Switch to turn on the power.

- Press "–" on the Power Switch behind of the printer for turning on the power.
- After [Initializing..] appears on the LCD Panel, the operating indicator turns blue and [Ready to Print] appears.
- Press "O" on the Power Switch for turning off the power.

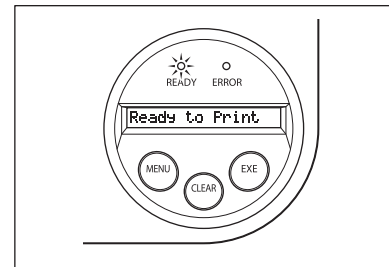

- If a card is still in the printer when the power is turned off, it is ejected from Card Ejection Slot 1 (default setting).



REF

- If the ERROR Indicator turns red, refer to "Troubleshooting" on page 36.

Loading Cards

Cards can be loaded in the Card Case and the Card Feeding Slot.

The Card Case can be loaded with a large quantity of cards, making it useful for mass printing. Use the Card Feeding Slot to manually load cards when you want to print only 1 particular card or to print many types of cards.

- CAUTION**
- Use cards recommended by your reseller.
 - See "Cards" on page 43 for details about which cards you can use.
 - Do not use the following cards:
 - Cards previously printed with this card printer or any other one.
 - Wet cards
 - Cards mixed with glass, metallic or other foreign objects
 - Embossed cards
 - Cards coated with oil or other foreign matter
 - Cracked, chipped, bent or otherwise damaged cards
 - Transparent cards
 - Abnormally shaped cards

■ Loading Cards into the Card Case

- 1 Open the Card Case cover.**
- While pulling the lock lever, open the cover towards you.

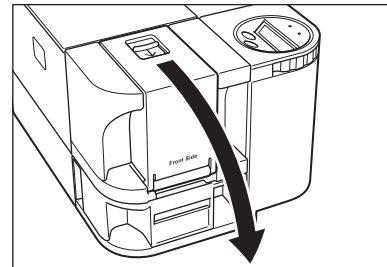

- 2 Lift up the weight and load the cards.**
- Load the Card Case so the cards are printing side up.
 - When loading the cards, be sure to pinch the edge of them. Never touch the printing side.

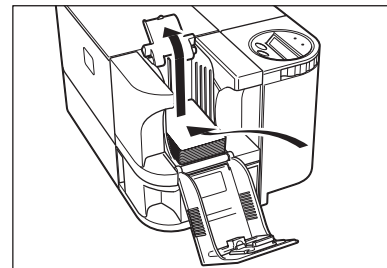
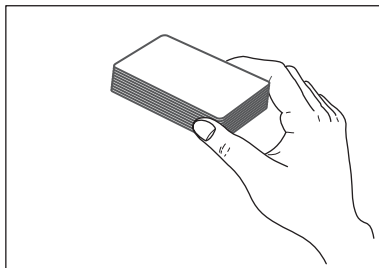

- 3 Lower the weight and close the cover.**

Full Color Card Printer **PR-C101/C101M**

Note

- The Card Case can be removed from the printer, allowing you to load cards into the Card Case before reattaching it.
- In order to prevent unauthorized printing, we recommend storing loaded Card Cases separately from the printer.
→See "How to Store Cards (Removing the Card Case)" on page 31 for information on the how to remove the Card Case.

■ Manually Loading Cards One by One

1**Remove the cards from the Card Case.**

- [Card Empty] appears on the LCD Panel.

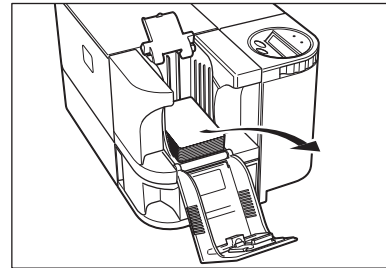
**2****Insert cards and press the CLEAR Key.**

- Insert cards with the printing side up into the Card Feeding Slot and press the CLEAR Key.
- [Ready to Print] appears on the LCD Panel.

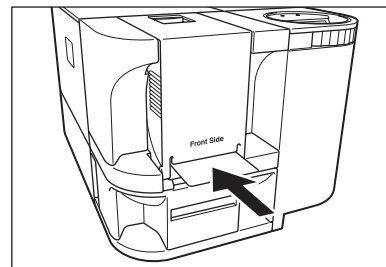
**Note**

- Printing occurs on the top side of the card.
Load the cards for printing so that after printing the printed side faces the Operation Panel.
- The bottom side of the card is for writing data to the magnetic strip.
Load the cards for writing data to the magnetic strip so that the magnetic strip faces the bottom side of the Operation Panel. (PR-C101M only)
- When printing begins the bottom card is pulled into the printer.

Printing

REF

- Command/menu names and the order of the procedure may differ depending on your application software. For more information on operations, refer to the instruction manual for your application software.
- Also, for more information about printer driver operations, refer to the driver help files.
- The explanations in this manual are based on screens that appear when using Windows Vista.

1 Turn on the printer and load the cards.

- →See "Loading Cards" on page 9 for information on how to load the cards correctly.

2 Launch your application software to create a document.

3 From the [File] menu of your application software, select [Print].

- Open the printer driver settings screen.

4 Specify various settings for printing if necessary.

- Select [Nisca PR-C101] if it is not already selected.
- Click [Preferences] (or [Properties]), and set the card size and the number of cards to be printed.
- Click [OK] when setup is complete.

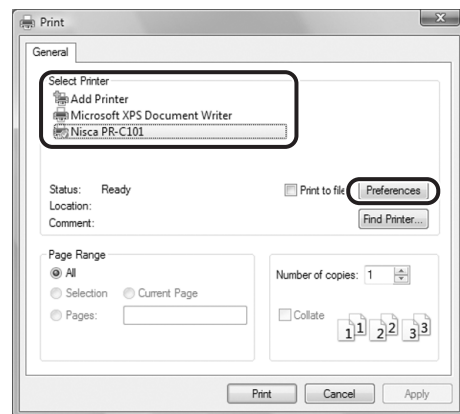

REF

- For more information about how to change the settings of the printer driver, refer to the driver help files.

Full Color Card Printer PR-C101/C101M

5 Click [Print].

- Printing starts.
- Cards are pulled into the printer and the READY Indicator blinks.
[Now Printing..] appears on the LCD Panel.

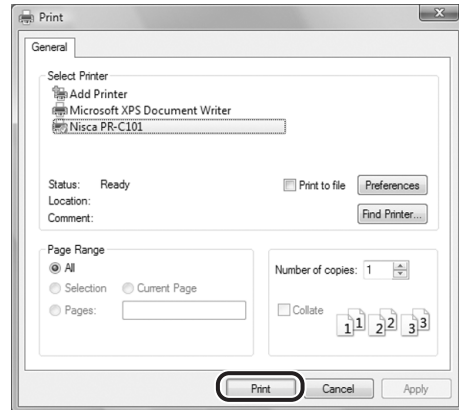

Removing Cards

The factory default is for printed cards to be ejected from Card Ejection Slot 1.

1 Pull out Card Ejection Slot 1 Tray.

- The Card Ejection Slot 1 tray can be pulled out in two directions. (See the illustration to the right)

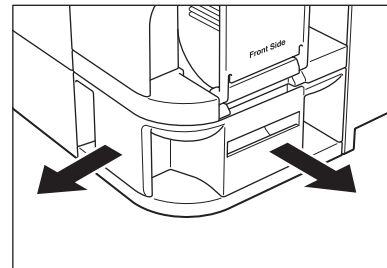

- Note**
- The Card Ejection Slot 1 tray has a maximum capacity of approximately 30 cards. If the cards printed exceed the maximum capacity of the tray, it will eject from the slit of the tray. Before the tray is filled to capacity, making it empty is recommended.
 - The factory default is for both correctly printed cards and cards with errors to be ejected from Card Ejection Slot 1. You can easily sort cards with errors by attaching a Card Stacker and setting cards with errors to be ejected to Card Ejection Slot 2.
→See "Switching the Card Ejection Slot" on page 21 for information about switching the card ejection slot and attaching the Card Stacker.

Changing the Ink Ribbon Cartridge

Change the Ink Ribbon Cartridge when the ink ribbon runs out.

You can use the following Ink Ribbon Cartridges:

- PR50025UC (Overcoating Color Ink Ribbon: YMCKO)
- PR5002KOC (Overcoating Black Ink Ribbon: KO)
- PR5002KC (Black Ink Ribbon: K)

→See "Ink Ribbon Cartridges" on page 42 for details about Ink Ribbon Cartridges.

Note

- You can check the amount of ink ribbon remaining. If the amount of ink ribbon remaining comes near to an end, the ERROR indicator blinks.

→See "Checking the Ink Ribbon Remaining in the Ink Ribbon Cartridge" on page 22 for instructions on how to check the amount of ink ribbon remaining.

■ When a Change is Necessary

The Ink Ribbon Cartridge must be changed when the [Rbn End] error message appears on the LCD Panel.

Note

- The number of printable sides with the Ink Ribbon Cartridge may decrease under the following conditions:

→See "Consumables" on page 42 for details about the number of printable sides with an Ink Ribbon Cartridge.

- When the Ink Ribbon Cartridge is removed during printing
- When an error occurs during printing
- Performing operations not listed in this manual
- Use the Ink Ribbon Cartridge as soon as possible after purchase.

■ Changing the Cartridge

Use the following procedure if it is necessary to change the ink cartridge.

1 Open the Front Cover.

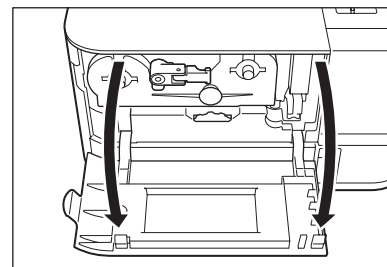

Full Color Card Printer PR-C101/C101M

2 Lift the Ink Ribbon Cartridge Securing Lever and remove the used Ink Ribbon Cartridge.

- Raise the lever's handle and after pulling it towards you, rotate the lever to the left.
- After pressing the lever in, remove the Ink Ribbon Cartridge.

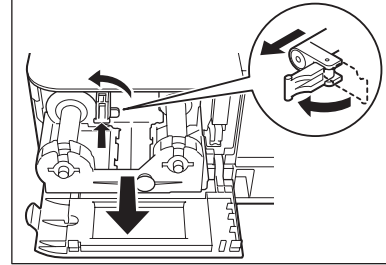

3 Remove the Cleaning Tape Protector and the fixing tape from the new Ink Ribbon Cartridge.

- Remove the new Ink Ribbon Cartridge from the box and the bag, and then remove the Cleaning Tape Protector from the Cleaning Assist Roller and the Ink Ribbon Fixing Tape.

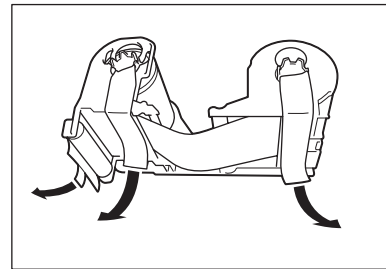

4 Load the new Ink Ribbon Cartridge.

- Fully insert the Ink Ribbon Cartridge.
- Do not insert the cartridge to the printer with ink ribbon slacked.

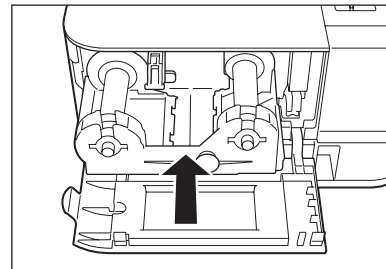

5 Lower the Ink Ribbon Cartridge Securing Lever and close the Front Cover.

- Pull the lever towards you and rotate it to the right. With the lever lowered, press it in and fold in the handle.

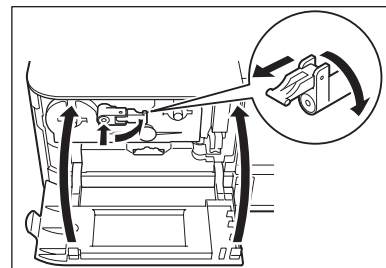

6 Press the CLEAR Key.

- Press the CLEAR Key if [Push CLEAR Key] appears on the screen and then [Ready to Print] appears.
- Clear an error first if the error message appears on the screen and then press the CLEAR Key.
→See "When an Error Message Appears..." on page 36.

Normal Mode and User Mode

You can switch the printer from Normal Mode to User Mode while it is operating.

This section provides an outline of both modes, explains how to change modes and explains the basic operations of the User Mode.

Normal Mode and User Mode

■ Normal Mode

Normal Mode is used for printing cards.

When the power is turned on the printer starts in Normal Mode.

The printer's status, such as [Ready to Print] or [Card Empty], appears on the LCD Panel.

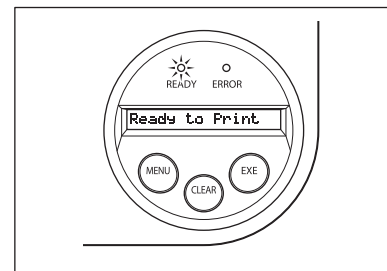

■ User Mode

User Mode is used to set operations and check the status of the printer.

To switch to the User Mode from the Normal Mode, hold down the Menu Key for more than three seconds and then press the EXE Key.

→See "Switching to User Mode" on page 16 for details on how to switch modes.

A list of menus, such as [Card Count] and [Color Adjust] are displayed on the LCD Panel.

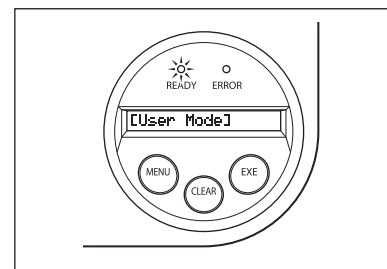

Full Color Card Printer PR-C101/C101M

Switching to User Mode

This section explains how to switch from Normal Mode to User Mode.

→See "Switching to Normal Mode (Exiting User Mode)" on page 18 for how to switch from User Mode to Normal Mode.

1 Press the Power Switch to turn on the power.

- When the power starts in the printer turns on in Normal Mode and [Ready to Print] appears on the LCD Panel.

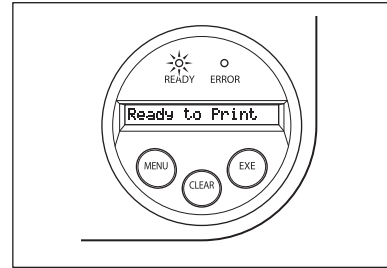

2 Press the Menu Key for more than three seconds and then release it.

- While you are holding down the Menu Key [Input Commands] appears on the LCD Panel.
- When [User Mode] appears on the LCD Panel after three seconds, release the key. [User Mode >>] appears on the LCD Panel.

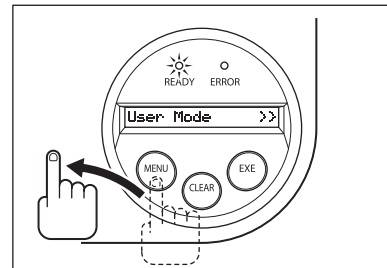

3 Press the EXE Key.

- [[User Mode]] appears on the LCD Panel and the printer enters the User Mode.

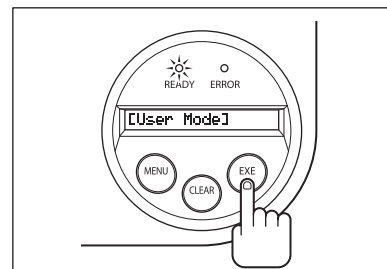

Note

- You can use the procedure above to enter the User Mode even when a printer error occurs.
- You can return to Normal Mode by pressing the CLEAR Key while [User Mode >>] is displayed.

Basic User Mode Operations

The User Mode has multiple menus in a hierarchical tree organized according to function.

This section explains how to switch menus in the User Mode hierarchy tree and how to switch from User Mode to Normal Mode.

→See "Menu Route Map (User Mode)" on page 44 for details about the menu tree configuration.

→See "Getting the Most Out of Your Printer" on page 19 for details on the functions of each menu.

Note ● Look at the "Menu Route Map (User Mode)" on page 44 while reading this section.

■ Moving to the Next Menu (Switching to Menus on the Same Level)

You can move to the next menu from any menu in the User Mode by pressing the Menu Key.

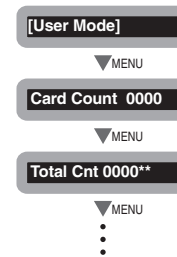

■ Moving to a Sub-menu (Switching to Menus on a Lower Level)

You can move to available sub-menus by pressing the EXE Key ([>>]) on a menu's right indicates a sub-menu.

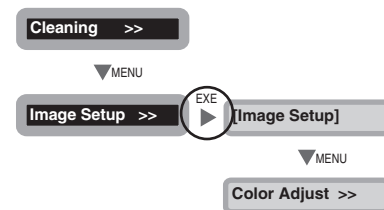

Full Color Card Printer PR-C101/C101M

■ Returning to the Main Menu (Switching to Menus on a Higher Level)

Each sub-menu has a [Parent Menu <<] menu for moving to a higher level.
 Press the Menu Key several times to switch to the [Parent Menu <<] menu and then press the EXE Key to return to the main menu.

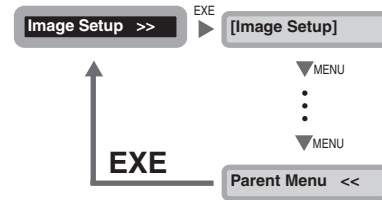

■ Switching to Normal Mode (Exiting User Mode)

Each level has a [Normal Mode <<<] menu for exiting User Mode.
 Press the Menu Key several times to switch to the [Normal Mode <<<] menu and then press the EXE Key to return to the Normal Mode.

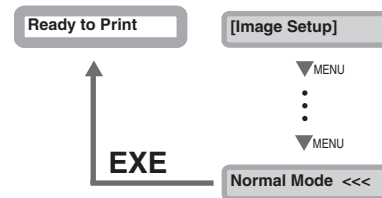

-
- Important**
- After changing the printer's setting on a menu, press the Menu Key to switch to the next menu.
 If you turn off the power without switching to the next menu, the changes will not be saved.
 (Changes to the settings are saved when you switch to the next menu.)

Getting the Most Out of Your Printer

This section explains how to check the printer's status and change the printer's settings.

Reprinting a Card that Has Just Been Printed

You can change the printer's settings so that just by pressing the EXE Key you can reprint a card with the same contents as the previous card.

- Note**
- You can also change the setting by using the printer driver. (→See "Opening the Printer Driver Settings Screen" on page 47.)

1 Switch from Normal Mode to User Mode.

→See "Switching to User Mode" on page 16 for details on how to switch to User Mode.

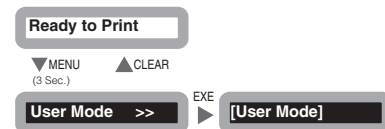

2 Press the Menu Key until [Printer Setup >>] appears, and then press the EXE Key.

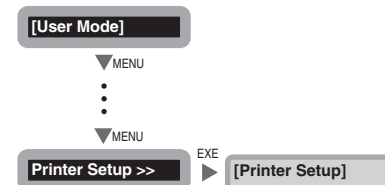

3 Press the Menu Key until [EXE Print] appears, and then press the EXE Key.

- Pressing the EXE Key switches between [ON] and [OFF].
- Set it to [ON] to enable reprinting by pressing the EXE Key, or [OFF] to disable it.

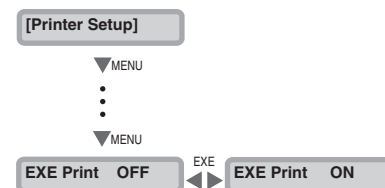

- CAUTION**
- The factory default setting is [OFF].
 - Reprinting with the EXE Key cannot be used while successively printing cards that have different content, such as when printing employee IDs for several people.
 - After turning off the power, reprinting a card with the same contents as the previous card is disabled.

Full Color Card Printer PR-C101/C101M

Counting the Number of Cards that Are Printed

You can count the number of cards that are printed.
 You can also count the number of cards that have been printed in a specified period of time by resetting the count with the CLEAR Key.

- Note**
- You can also count the number of cards printed by using the printer driver. (→See "Opening the Printer Driver Settings Screen" on page 47.)

1 Switch from Normal Mode to User Mode.

→See "Switching to User Mode" on page 16 for details on how to switch to User Mode.

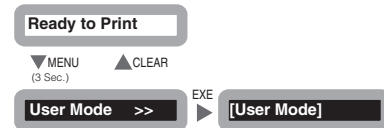

2 Press the MENU Key until [Card Count] appears.

- The number of cards that are printed appears.
- Pressing the CLEAR Key returns the count to [0].

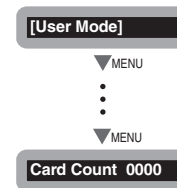

Displaying the Total Number of Sides that Are Printed

You can display the total number of sides (each card has two sides) that are printed. This can be used as a guideline for doing maintenance.

- Note**
- You can also display the status on the printer driver. (→See "Opening the Printer Driver Settings Screen" on page 47.)

1 Switch from Normal Mode to User Mode.

→See "Switching to User Mode" on page 16 for details on how to switch to User Mode.

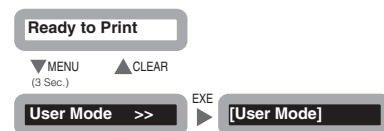

2 Press the MENU Key until [Total Cnt] appears.

- The total number of sides is displayed.

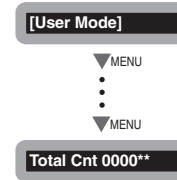

- CAUTION**
- The count cannot be reset.
 - The count display shows several cards have been printed when the printer is shipped from the factory because the count increases during the production process.

Switching the Card Ejection Slot

You can switch the slot from which printed cards are output to slot 1 or slot 2. The factory default is set so both correctly printed cards and cards with errors are output from Card Ejection Slot 1.

- Note**
- You can also change the setting by using the printer driver. (→See "Opening the Printer Driver Settings Screen" on page 47.)

1 Switch from Normal Mode to User Mode.

→See "Switching to User Mode" on page 16 for details on how to switch to User Mode.

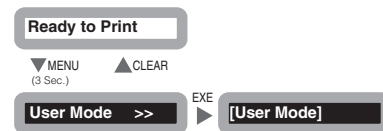

2 Press the Menu Key until [Printer Setup >>] appears, and then press the EXE Key.

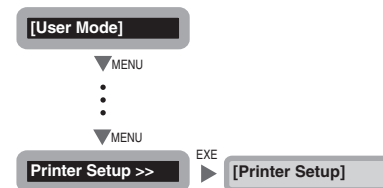

3 Press the Menu Key until [Card Exit >>] appears, and then press the EXE Key.

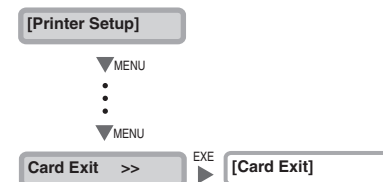

Full Color Card Printer PR-C101/C101M

4 Use the Menu Key to switch between [NORMAL] and [Error], and then change the setting with the EXE Key.

- Select where to output normal cards on the [Normal] menu, and where to output abnormal cards on the [Error] menu.
- Pressing the EXE Key switches between [EXIT-1] and [EXIT-2].
- Set it to [EXIT-1] to output cards from Card Ejection Slot 1, or [EXIT-2] to do from Card Ejection Slot 2.

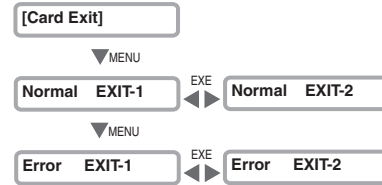

- Note**
- Attach the Card Stacker to Card Ejection Slot 2 when Card Ejection Slot 2 is selected.

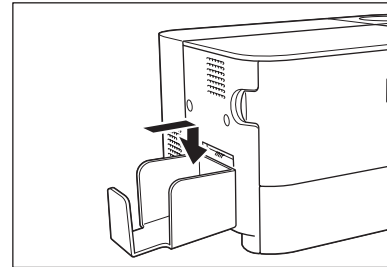

Checking the Ink Ribbon Remaining in the Ink Ribbon Cartridge

You can check the amount of ink ribbon that is remaining in the Ink Ribbon Cartridge.

- Note**
- You can also display the status on the printer driver. (→See "Opening the Printer Driver Settings Screen" on page 47.)

1 Switch from Normal Mode to User Mode.

→See "Switching to User Mode" on page 16 for details on how to switch to User Mode.

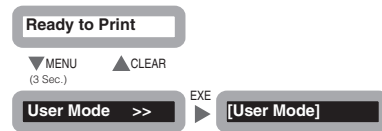

2 Press the Menu Key until [Ribbon Info. >>] appears, and then press the EXE Key.

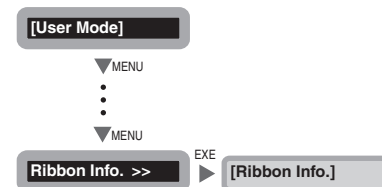

3 Press the Menu Key until [Remainder(%)] appears.

- The amount of ink ribbon in the Ink Ribbon Cartridge is shown as a percent.

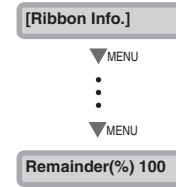

Checking the Ink Ribbon Cartridge that is Currently Installed

You can check the type and lot number of the Ink Ribbon Cartridge that is currently installed.

→See "Changing the Ink Ribbon Cartridge" on page 13 for how to change the Ink Ribbon Cartridge.

→See "Ink Ribbon Cartridges" on page 42 for details about which Ink Ribbon Cartridges you can use.

Note

- You can also display the status on the printer driver. (→See "Opening the Printer Driver Settings Screen" on page 47.)
- You can confirm the following information.
 - Type of Ink Ribbon Cartridge (display is [Type])**
 - Lot number of Ink Ribbon Cartridge (display is [Lot])**
 - Serial number of Ink Ribbon Cartridge (display is [Serial])**

1 Switch from Normal Mode to User Mode.

→See "Switching to User Mode" on page 16 for details on how to switch to User Mode.

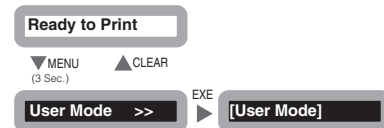

2 Press the Menu Key until [Ribbon Info. >>] appears, and then press the EXE Key.

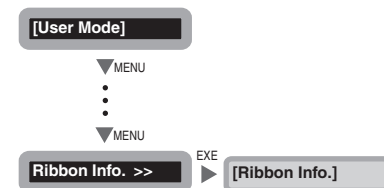

3 Press the Menu Key to display the information you want to check.

- Pressing the Menu Key switches between [Type], [Lot], and [Serial].

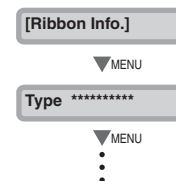

Full Color Card Printer PR-C101/C101M

Adjusting the Print Quality

You can adjust the print quality by adjusting the speed or making colors darker or lighter.

- Note** ● You can also change the setting by using the printer driver. (→See "Opening the Printer Driver Settings Screen" on page 47.)

■ Adjusting the Color

You can adjust tones of yellow, magenta, cyan, and black. The tones of yellow, magenta, and cyan images are adjustable and you can change the width of black text.

1 Switch from Normal Mode to User Mode.

→See "Switching to User Mode" on page 16 for details on how to switch to User Mode.

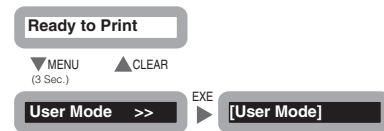

2 Press the Menu Key until [Image Setup >>] appears, and then press the EXE Key.

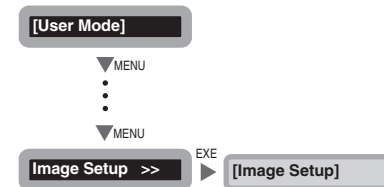

3 Press the Menu Key until [Color Adjust >>] appears, and then press the EXE Key.

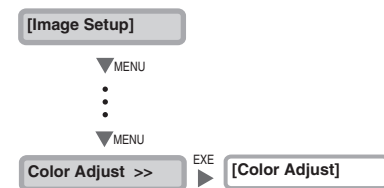

Getting the Most Out of Your Printer

4 Select the color to adjust using the Menu Key, and then press either the EXE Key or the CLEAR Key to change the settings.

- Pressing the Menu Key switches between [Yellow], [Magenta], [Cyan], and [Black].
- Pressing the EXE Key darkens the color, by changing the value to 0, 1, 2, or 3.
- Pressing the CLEAR Key lightens the color by changing the value to 0, -1, -2, or -3.



Note • The factory default setting for all colors is "0".

Full Color Card Printer PR-C101/C101M

■ Adjusting the Edges of Images

You can adjust facial contours or the definition of edges of images.

1 Switch from Normal Mode to User Mode.

→See "Switching to User Mode" on page 16 for details on how to switch to User Mode.

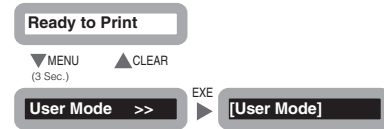

2 Press the Menu Key until [Image Setup >>] appears, and then press the EXE Key.

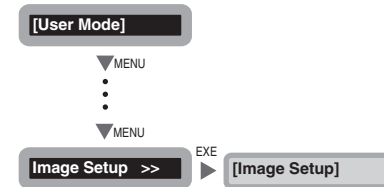

3 Press the Menu Key until [Sharpness] appears, and then press the EXE Key or the CLEAR Key to change the settings.

- Pressing the EXE Key darkens outlines by changing the value to 0, 1, or 2.
- Pressing the CLEAR Key lightens outlines by changing the value to 0, -1, or -2.

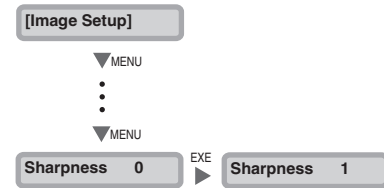

Note • The factory default setting is [0].

Turning the Error Alarm On or Off

The initial setting is for the buzzer to sound when an error occurs. You can set the buzzer so that it does not sound.

Note • You can also change the setting by using the printer driver. (→See "Opening the Printer Driver Settings Screen" on page 47.)

1 Switch from Normal Mode to User Mode.

→See "Switching to User Mode" on page 16 for details on how to switch to User Mode.

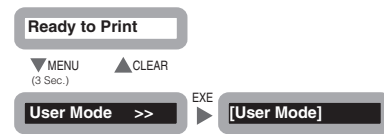

2 Press the Menu Key until [Printer Setup >>] appears, and then press the EXE Key.

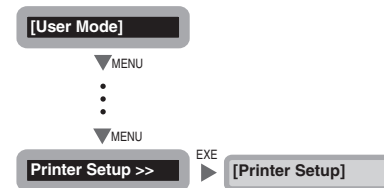

3 Press the Menu Key until [Buzzer] appears, and then press the EXE Key to change the settings.

- Pressing the EXE Key switches between [ON] and [OFF].
- Set it to [ON] to sound the buzzer or [OFF] to turn the buzzer off.

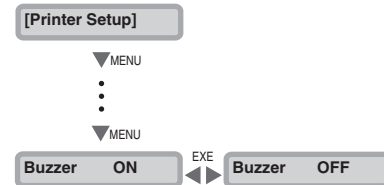

Full Color Card Printer PR-C101/C101M

Setting the Printer to Reprint a Card if an Error Occurs

You can change the settings so that cards being printed when an error occurs are automatically reprinted after the error is fixed.

This is useful to prevent omissions due to errors when printing cards in a series, such as employee IDs.

- Note** • You can also change the setting by using the printer driver. (→See "Opening the Printer Driver Settings Screen" on page 47.)

1 Switch from Normal Mode to User Mode.

→See "Switching to User Mode" on page 16 for details on how to switch to User Mode.

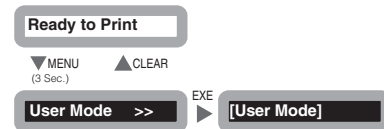

2 Press the Menu Key until [Printer Setup >>] appears, and then press the EXE Key.

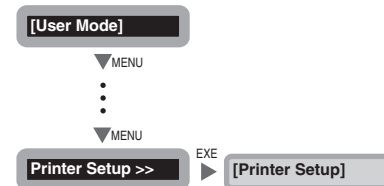

3 Press the Menu Key until [Retry Print] appears, and then press the EXE Key.

- Pressing the EXE Key switches between [ON] and [OFF].
- Set to [ON] to reprint cards after an error or set it to [OFF] to not reprint the cards.

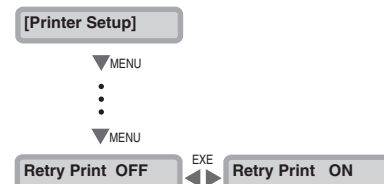

- Note** • The factory default setting is [OFF].
- If the printer is restarted to fix the error, the card that was being printed during the error is not automatically reprinted.

Checking the Program Information and Serial Number

You can check the version of the program and the printer's serial number.

- Note**
- You can also display the status on the printer driver. (→See "Opening the Printer Driver Settings Screen" on page 47.)
 - You can confirm the following information.
 - Version of the base program (display is [Base Ver..])**
 - Version of the main program (display is [Main Ver..])**
The version of the program that starts when the power is turned on.
 You can download a file to update the program.
 →See "Updating the Printer's Software" on page 43 for updating instructions.
 - Printer's serial number (display is [Serial])**
 - Thermal head's number (display is [Head])**
 - Version of the magnetic encoder (screen display [Encoder]) (PR-C101M only)**
Magnetic encoder standard information (ISO/JIS2) and version information.

1 Switch from Normal Mode to User Mode.

→See "Switching to User Mode" on page 16 for details on how to switch to User Mode.

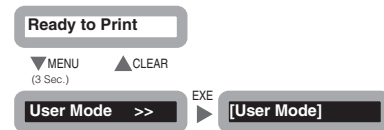

2 Press the Menu Key until [Printer Info. >>] appears, and then press the EXE Key.

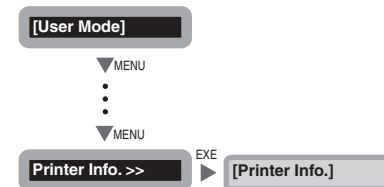

3 Press the Menu Key to display the information to check.

- Pressing the Menu Key switches between [Base Ver.], [Main Ver.], [Serial], [Head], and [Encoder].

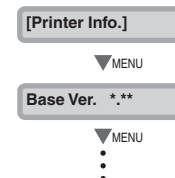

Full Color Card Printer PR-C101/C101M

Changing the Magnetic Encoder's Settings (PR-C101M Only)

You can switch the coercivity (Hi-Co or Lo-Co) when writing magnetic data.

- Note** • You can also change the setting by using the printer driver. (→See "Opening the Printer Driver Settings Screen" on page 47.)

1 Switch from Normal Mode to User Mode.

→See "Switching to User Mode" on page 16 for details on how to switch to User Mode.

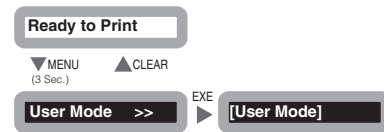

2 Press the Menu Key until [Printer Setup >>] appears, and then press the EXE Key.

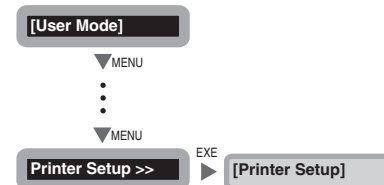

3 Press the Menu Key until [Encode Type] appears, and then press the EXE Key.

- Pressing the EXE Key switches between [LOCO] and [HICO].

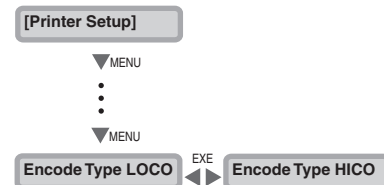

Returning Settings to the Default

You can restore changed settings to their initial factory default settings.

The following settings can be returned to their initial settings.

- **[Card Count] value (the [Total Count] value cannot be initialized).**
- **Settings on the sub menus in [Printer Setup].**
- **Settings on the sub menus in [Image Setup].**

Getting the Most Out of Your Printer

1 Switch from Normal Mode to User Mode.

→See "Switching to User Mode" on page 16 for details on how to switch to User Mode.

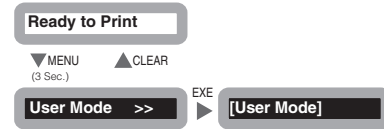

2 Press the Menu Key until [Setup Reset[C+E]] appears, and then press the EXE Key and the CLEAR Key at the same time.

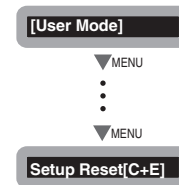

Preventing Theft and Unauthorized Usage

■ Preventing Theft of the Printer (Security Cable Slot)

You can prevent theft of the printer by locking it with a wire cable.

Use a wire cable that fits the Security Cable Slot (0.12" x 0.28" (3.00 mm x 7.00 mm)) to lock up the printer.

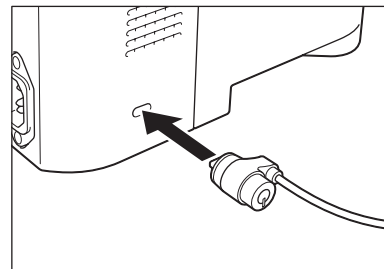

Note • Use a commercial security cable.

■ How to Store Cards (Removing the Card Case)

You can prevent unauthorized use of the cards by removing the Card Case and locking it in a safe or other secure location.

1 Pull the Card Case as indicated by arrow in the illustration.

- Grip the Card Case by the embossing on its sides and pull it forward and down.
- When you hear a click remove the Card Case.

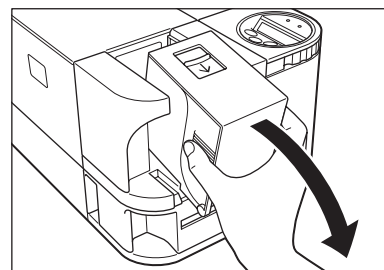

Full Color Card Printer PR-C101/C101M

Cleaning

The rollers need to be cleaned to maintain good print quality. This section explains which rollers need to be cleaned and how to clean them.

Before Cleaning

Note the following cautions when cleaning the rollers.

- CAUTION**
- Do not clean the rollers near an open flame.
 - Remove any cards that are inside the printer.
 - After cleaning the rollers, do not use the printer until the rollers get dry (for at least five minutes).
 - Do not touch the rollers with your bare hands.

Cleaning with a Cleaning Card

Use the Cleaning Card (provided) to clean the Card Transport Roller if cards do not feed smoothly.

We recommend cleaning the rollers after printing about 1,000 cards.

→See "Cleaning Cards" on page 43 for details about which Cleaning Cards you can use.

- Note**
- The [Card Count] and [Total Count] functions make it easy to keep track of how many cards are printed.
 - See "Counting the Number of Cards that Are Printed" on page 20 for details about the [Card Count] function.
 - See "Displaying the Total Number of Sides that Are Printed" on page 20 for details about the [Total Count] function.

- CAUTION**
- Cleaning Cards can only be used once and cannot be reused. Use a new Cleaning Card every time you clean the rollers.

1 Turn on the power and switch from Normal Mode to User Mode.

→See "Switching to User Mode" on page 16 for details on how to switch to User Mode.

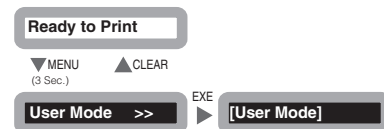

Cleaning

2 Press the Menu Key until [Cleaning >>] appears and then press the EXE Key.

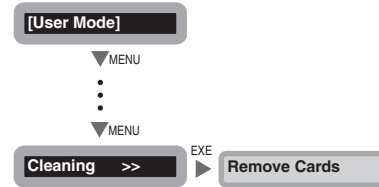

3 Remove the cards from the Card Case and then press the EXE Key.

- If cards are loaded, [Remove Cards] appears.
- When the cards have been removed, [Push EXE (NEXT)] appears.

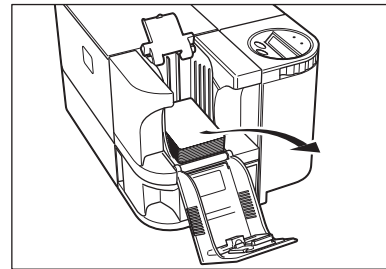

4 [Set Cleaning Crd] appears when the Cleaning Card is loaded.

- Remove the protection sheet from the sticky surface of the Cleaning Card, and then load it with the sticky surface face down.
- When the Cleaning Card is loaded, [Push EXE (Start)] appears.

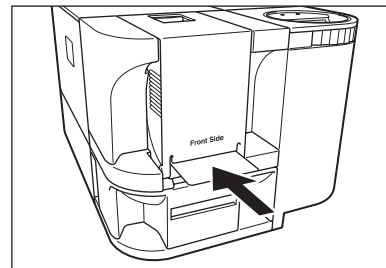

5 Press the EXE Key.

- The Cleaning Card is pulled into the printer and cleaning starts.
- The Cleaning Card comes out of the Card Ejection Slot 1 when cleaning is completed.

Full Color Card Printer PR-C101/C101M

Cleaning the Cleaning Roller

Clean the Cleaning Roller if cards are printed with missing colors or if there are foreign objects on them.

- CAUTION**
- Be sure to turn off the printer before cleaning the rollers.
 - Read the cautions in "Before Cleaning" on page 32.

1 Turn off the power.

2 Open the Front Cover.

- Open the Front Cover towards you.

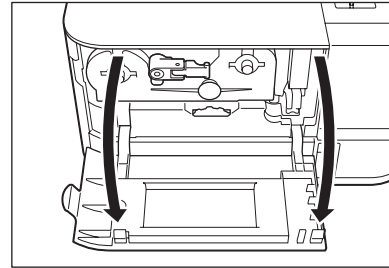

3 Remove the Cleaning Roller.

- To remove the Cleaning Roller, pinch the grip located on the right side of the Ink Ribbon Cartridge, and pull it out.

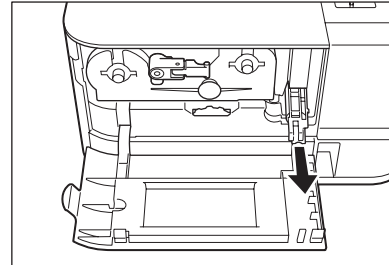

4 Wipe the roller clean.

- Use a soft cloth imbued with **water** to wipe the roller clean.

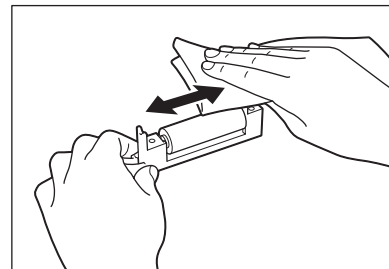

5 Insert the Cleaning Roller and close the Front Cover.

- Line up the slide with the rail on the printer and insert it all the way.

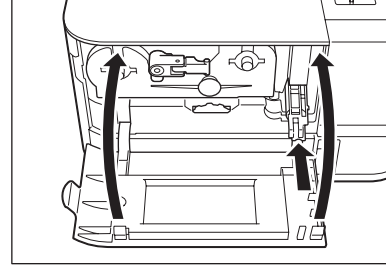

Cleaning the Feeding Roller

Clean the Feeding Roller under the Card Case if cards do not feed smoothly into the printer.

- CAUTION**
- Be sure to turn off the printer before cleaning the rollers.
 - Read the cautions in "Before Cleaning" on page 32.
 - Do not use any solvents other than very pure alcohol.

1 Turn off the power.

2 Remove the Card Case.

- Grip the Card Case by the ridges on its side and pull it as indicated by arrow in the illustration.

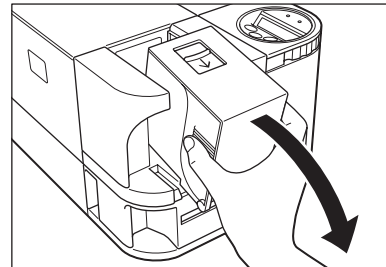

3 Wipe the roller clean.

- Use a soft cloth and **very pure alcohol** to wipe the roller clean.
- Turn the roller as you wipe it to clean it in the direction of an arrow.

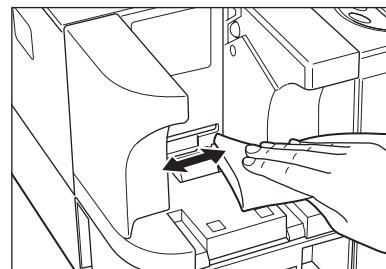

Full Color Card Printer PR-C101/C101M

Troubleshooting

This section explains what to do when an error message appears, a card is jammed, or there is a problem with the printed side of a card.

When an Error Message Appears...

The ERROR Indicator is lit and a description of the error appears on the LCD Panel when an error occurs.

■ Clearing an Error

Follow the instructions below to clear an error.

After clearing an error, [Ready to Print] appears when the CLEAR Key is pressed and the printer is returned to normal status.

Note

- When two errors occur, only the first error message is displayed. Pressing the CLEAR Key after clearing the first error displays the next error. Continue to clear errors until [Ready to Print] appears.

■ How to Clear an Error

Resolve error messages that appear on the LCD Panel according to the instructions below.

Error message	Cause and solution
Cover Open XX-XX	The Front Cover is opening. ⇒Make sure the Front Cover is closed.
Card Empty XX-XX	There are no more cards. ⇒Load cards into the printer. →See "Loading Cards" on page 9 for instructions on loading cards.
Rbn End XX-XX	The ink ribbon has been used up. ⇒Change the Ink Ribbon Cartridge. →See "Changing the Ink Ribbon Cartridge" on page 13 for details about changing the Ink Ribbon Cartridge.

Error message	Cause and solution
<p>Rbn Type XX-XX</p>	<p>Ink ribbon position control has failed. ⇒Reload the Ink Ribbon Cartridge. →See "Changing the Ink Ribbon Cartridge" on page 13 for details about changing the Ink Ribbon Cartridge.</p>
<p>Rbn Wind XX-XX</p>	<p>The ink ribbon could not be wound correctly. ⇒Reload the Ink Ribbon Cartridge. →See "Changing the Ink Ribbon Cartridge" on page 13 for details about changing the Ink Ribbon Cartridge.</p>
<p>Feed Miss XX-XX</p>	<p>Cards cannot be fed into printer. ⇒Press the CLEAR Key.</p> <p>Frequent occurrences of this error may mean the following:</p> <p>Is the Card Case loaded correctly? ⇒Correctly load the Card Case. ⇒Check that the Card Case weight is lowered. →See "Loading Cards" on page 9 for instructions on loading cards.</p> <p>Is the Feeding Roller dirty? ⇒Clean the Feeding Roller located below the Card Case. →See "Cleaning the Feeding Roller" on page 35 for instructions on cleaning the Feeding Roller.</p>
<p>Card Jam. XX-XX</p>	<p>There was a card jam. ⇒Press the CLEAR Key.</p> <p>Frequent card jams could mean the following:</p> <p>Is the Card Transport Roller dirty? ⇒Clean the Card Transport Roller. ⇒If the Card Transport Roller is excessively dirty, continue cleaning using a new Cleaning Card. →See "Cleaning with a Cleaning Card" on page 32 for instructions on cleaning the Card Transport Roller.</p>
<p>MG Write XX-XX</p>	<p>Writing to the magnetic strip failed. ⇒Press the CLEAR Key.</p> <p>Failure when writing to the magnetic strip may mean the following:</p> <p>Is the card set in the correct direction? ⇒Check the loading direction of the cards. →See "Loading Cards" on page 9 for instructions on loading cards.</p>

Full Color Card Printer PR-C101/C101M

Error message	Cause and solution
	<p>Are there any scratches or dirt on the card's magnetic strip? ⇒Use undamaged cards.</p> <p>Is the magnetic characteristics of the card matches the version of the magnetic encoder and the setting of the magnetic encoder? ⇒Check the version of the magnetic encoder. →See "Checking the Program Information and Serial Number" on page 29 for instructions on how to check the version of the magnetic encoder. ⇒Change the settings of the magnetic encoder. →See "Changing the Magnetic Encoder's Settings (PR-C101M Only)" on page 30 for information about changing the settings of the magnetic encoder.</p>
<p>MG Read XX-XX</p>	<p>Reading of the magnetic data failed. ⇒Press the CLEAR Key.</p> <p>Failure when reading the magnetic data may mean the following:</p> <p>Is the card set in the correct direction? ⇒Check the loading direction of the cards. →See "Loading Cards" on page 9 for instructions on loading cards.</p> <p>Are there any scratches or dirt on the card's magnetic strip? ⇒If there are any dirt on the card, remove them. ⇒You cannot use the card with the scratches on the magnetic strip.</p>
<p>Service C. XX-XX</p>	<p>An error occurred that requires repairs.</p> <p>The cause of the error differs depending on the error code. ⇒Turn off and on the power or hold down the CLEAR Key for 3 seconds to reset the printer. Repairs are necessary if the error reoccurs.</p>

After clearing the errors above, pressing the CLEAR Key clears the errors and [Ready to Print] is displayed.

If the following messages appear, resolve the problem according to the instructions below.

Message	Solution
<p>Push CLEAR key.</p>	<p>Press the CLEAR Key.</p>
<p>Cover Open</p>	<p>Correctly close the cover.</p>

Message	Solution
Card Empty	Load cards into the printer. →See "Loading Cards" on page 9 for instructions on loading cards.
Remove Card	Remove the cards by rotating the Ejection Dial. →See "When a Card is Jammed..." on page 39 for instructions on how to remove cards.
Check Ink Ribbon	Change to a normal Ink Ribbon Cartridge. →See "Changing the Ink Ribbon Cartridge" on page 13 for details about changing the Ink Ribbon Cartridge.
Cannot Recover	Turn off and on the power. Repairs are necessary if the error reoccurs.

When a Card is Jammed...

Use the following procedure to remove cards jammed during printing or when the jammed card is unable to remove despite of CLEAR Key is pressed.

1 Remove cards from the Card Case.

- If the card on the bottom is partially fed into the machine, slowly pull it out by hand.
- The Card Case cannot be removed.

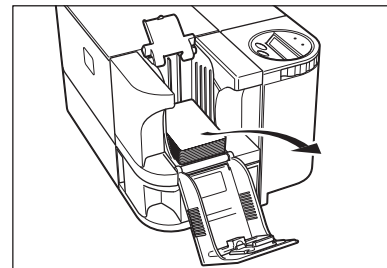

2 Open the Front Cover, and then rotate the Ejection Dial to the left.

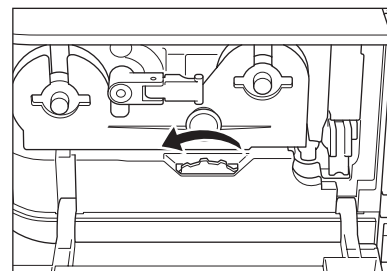

- Jammed cards are ejected from Card Ejection Slot 2.



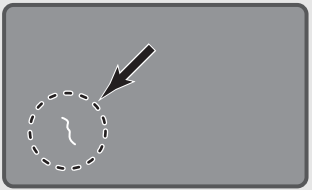
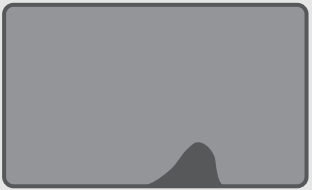

Full Color Card Printer PR-C101/C101M

When Cards are Not Printed Correctly...

If missing or incorrect colors are printed on a card or cards are incorrectly printed, resolve the problem according to the following instructions.

Problem	Cause and solution
<p>There are missing or incorrect colors in certain sections. Dirt is present.</p> 	<p>Is there dirt on the card surface? ⇒ Do not use dirty cards. ⇒ Avoid using the printer in locations with excessive dust or dirt. ⇒ Clean the Cleaning Roller. → See "Cleaning the Cleaning Roller" on page 34 for instructions on cleaning the Cleaning Roller.</p>
<p>There are incorrect colors within an indefinite range.</p> 	<p>Is there oil content attached on the card surface? ⇒ Do not touch the printing side of the card. Are you using incompatible cards? ⇒ Use only recommended cards. → See "Cards" on page 43 for details about which cards you can use.</p>
<p>White cards (unprinted cards) are output.</p> 	<p>Only color image data was received with the Overcoating Black Ink Ribbon or Black Ink Ribbon loaded. ⇒ Use the Overcoating Color Ink Ribbon when printing in color. → See "Changing the Ink Ribbon Cartridge" on page 13 for details about changing the Ink Ribbon Cartridge.</p>
<p>Fine lines are not printed.</p> 	<p>Contact your reseller.</p>

Problem	Cause and solution
<p>There is a surface irregularity.</p> 	<p>Contact your reseller.</p>
<p>The image suddenly changes colors during printing.</p> 	<p>Contact your reseller.</p>

Other Troubles

Problem	Solution
<p>The power cannot be turned on.</p>	<p>Make sure the power cable is connected.</p>
<p>Data cannot be sent to the printer.</p>	<p>Make sure the USB cable is connected.</p>

When These Solutions Don't Work...

Contact your reseller if errors appear which are not included in this manual or when an error cannot be cleared.

- Note**
- When contacting your reseller, provide them with the content of the message and the error code (XX-XX) that appears on the right side of the LCD Panel.

Cover Oper **XX-XX**

Full Color Card Printer PR-C101/C101M

Appendix

Consumables

■ Ink Ribbon Cartridges

The following three types of Ink Ribbon Cartridges can be used with the printer.

Name	Type	Model	Number of printable sides
Overcoating Color Ink Ribbon	YMCKO	PR50025UC	250 sides
Overcoating Black Ink Ribbon	KO	PR5002KOC	500 sides
Black Ink Ribbon	K	PR5002KC	1000 sides

- CAUTION**
- Do not use Ink Ribbon Cartridges other than those listed above. Doing so may cause a malfunction.
 - Touching the ink ribbon directly may cause uneven print density.
 - When changing the Ink Ribbon Cartridge, do not drop and make a big impact.

- Note**
- The number of printable sides may decrease under the following conditions.
 - Changing the Ink Ribbon Cartridge during use
 - When an error occurs during printing
 - Performing operations not listed in this manual
 - Use Ink Ribbon Cartridges as soon as possible after purchase.
 - When you store Ink Ribbon Cartridges, do not keep it in a location subject to direct sunlight, high temperature, high humidity, and dust.

■ Cards

Use only cards that conform to the CR-80 standard.

Size: 3.375" x 2.125" (86 mm x 54 mm) Thickness: 0.03" (0.76 mm)

Material: PVC.PET (Coating PVC or ink absorbing layer on printing side)

-
- ⚠ CAUTION**
- Use only cards that conform to the CR-80 standard. Otherwise cards may not be printed properly.
 - Do not use the following cards:
 - Cards previously printed with this card printer or any other one.
 - Wet cards
 - Cards mixed with glass, metallic or other foreign objects
 - Embossed cards
 - Cards coated with oil or other foreign matter
 - Cracked, chipped, bent or otherwise damaged cards
 - Transparent cards
 - Abnormally shaped cards

■ Cleaning Cards

Use the Nisca PR5500K574 Cleaning Card.

-
- ⚠ CAUTION**
- Do not use Cleaning Cards other than those listed above. Doing so may cause a malfunction.

Updating the Printer's Software

You can update the printer's software by downloading the printer's firmware program (main program) and the printer driver from the Nisca Web page.

For more information, visit Nisca's homepage at the address listed below.

<http://www.nisca.co.jp/>

Menu Route Map (User Mode)

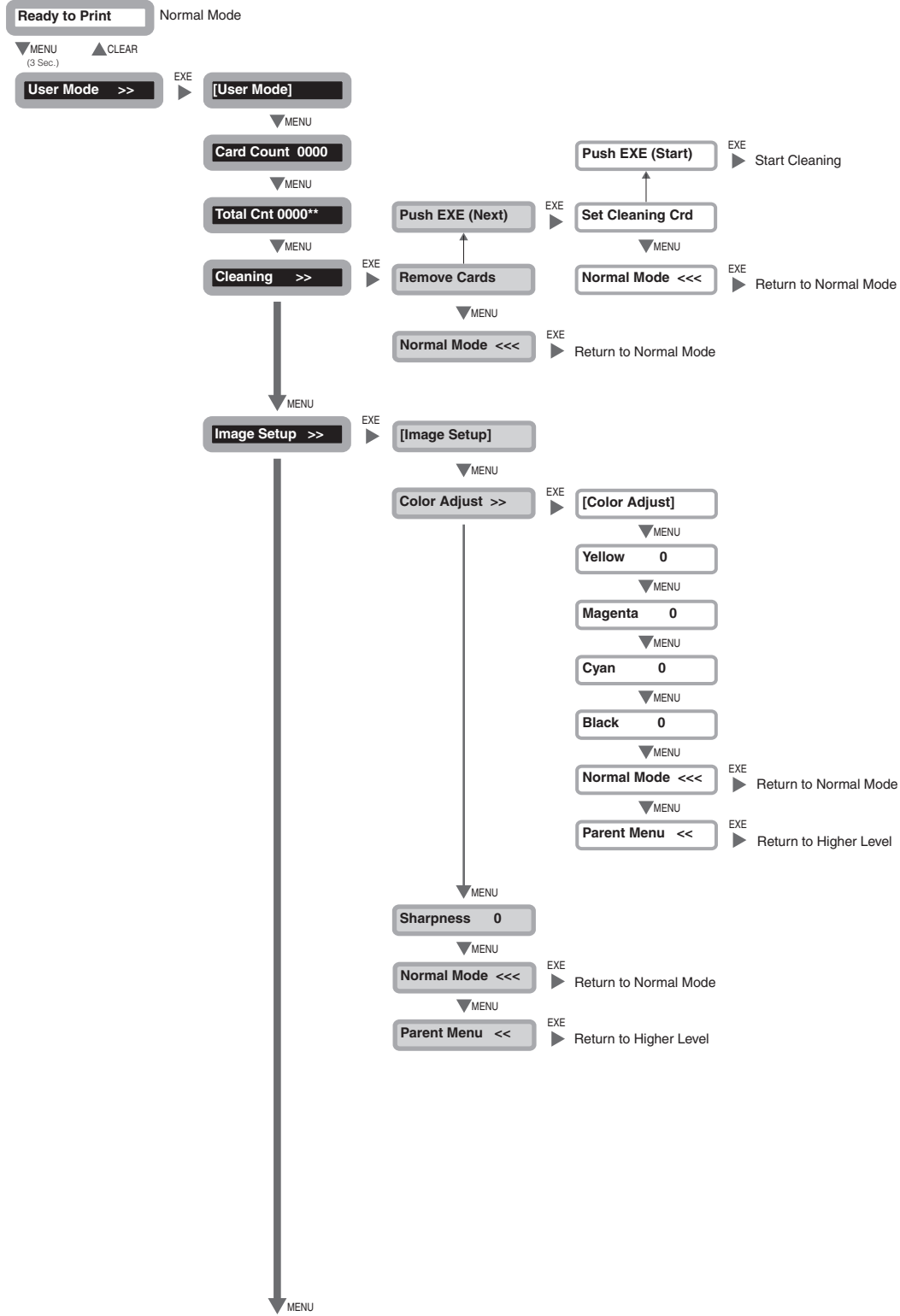

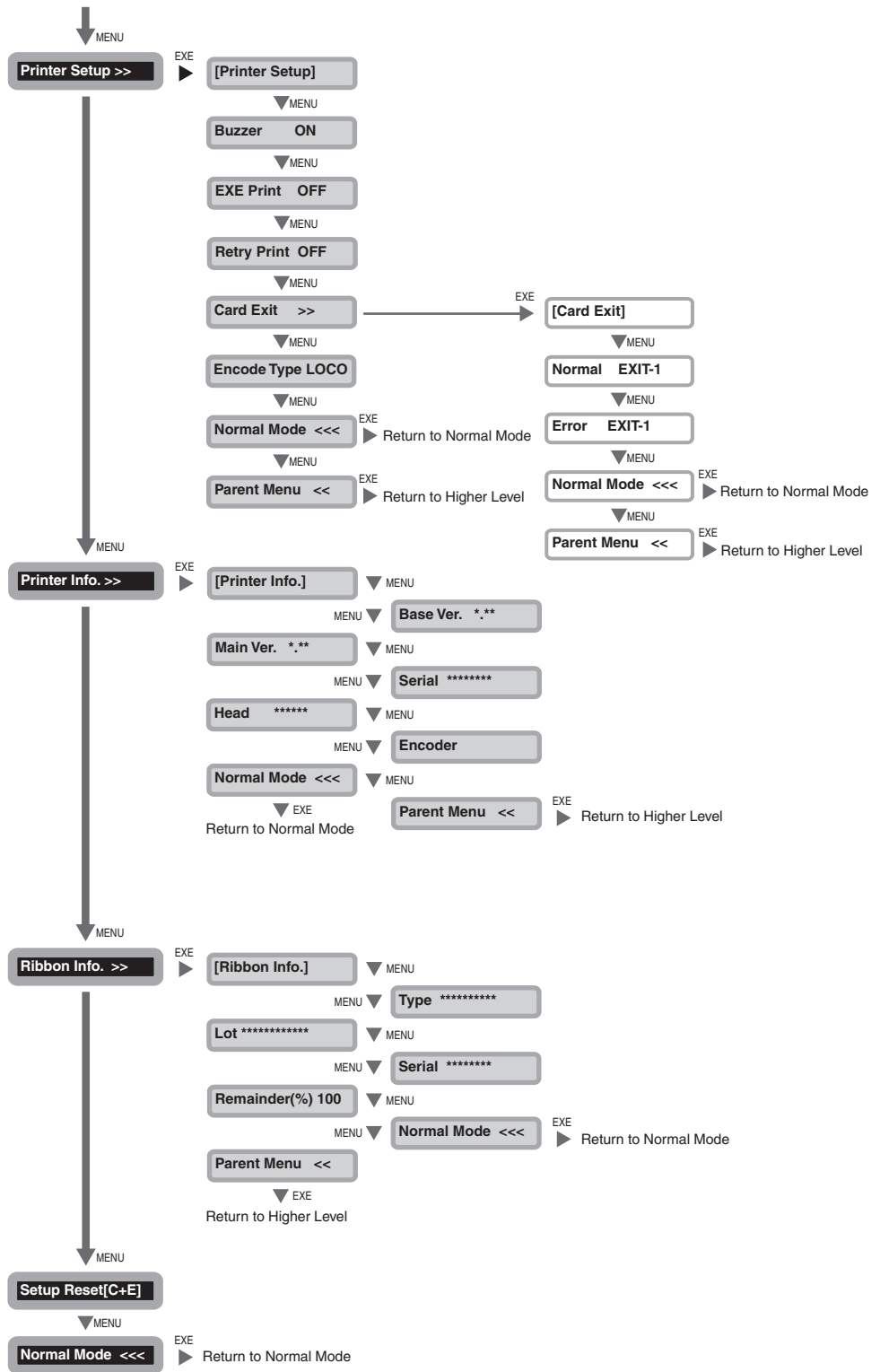

Full Color Card Printer PR-C101/C101M**Main Specifications**

	PR-C101	PR-C101M
Function	Full color print (1 side)	Full color print (1 side) Magnetic encode
Print media	PVC card Size and thickness according to CR-80	
Magnetic Specifications	—	Comply with ISO7811
Print quality	300 dpi	
Print tones	Input tones: RGB, 256 tones/color Output tones: YMC, 256 tones/color controlled	
Print area	3.46" x 2.16" (86.5 mm x 54 mm) Except for a 0.008" (0.2 mm) margin on the front edge.	
Print time	Approx. 25 seconds/card using 5 colors over the entire side (Factory default settings)	
Transfer ribbon	Overcoating Color Ink Ribbon/Overcoating Black Ink Ribbon/Black Ink Ribbon	
Feed method	Automatic feed from the Card Case (100 card auto feed) Manual feed	
Interface	USB 2.0 RS-232C (Port for Enhancing Function)	
Power source	AC 100/120, 220/240V, 50/60 Hz	
Power consumption	Less than 120 W	
Operating noise	While operating: Less than 50 dB While waiting: Less than 45 dB	
Dimensions	7.2" (H) x 13.16" (W) x 8.88" (D) (180 mm x 329 mm x 222 mm)	7.2" (H) x 15.2" (W) x 8.88" (D) (180 mm x 380 mm x 222 mm)
Weight	14.3 lb (6.5 kg)	17.6 lb (8 kg)
Operating environment	Temperature: 50 to 95°F/10 to 35°C Humidity: 35 to 85% RH (without condensation)	